







SR Linear Light

BLAZE SERIES



SUMMARY

dimension w: 35mm h: 48mm	length S: 236mm M: 476mm L: 956mm	mounting   	housing color  	
IP IP40 IP66	power S: 7W M: 13W L: 26W	beam 15° 20° 30° 45° 20°x40°	color 2700K 4000K 3000K 5000K 3500K	CRI Ra90+ Ra80+

FEATURES

- Elegant linear wall washer design
- Wide range of beam angle selections: 15°/20°/30°/45°/20°x40°
- Flexible mounting options: surface mount, adjustable bracket and magnetic mount
- Available in IP40 or IP66
- Long lifetime, 30,000 hours

DIMMING OPTIONS



LIGHT OUTPUT

CRI/CCT: 927, 930, 935, 940, 950, 827, 830, 835, 840, 850

Beam angle: 15°, 20°, 30°, 45°, 20°x40°

Luminaire Lumen Output @830:

SR Blaze	15°	20°	30°	45°	20°x40°
S	544	556	564	512	436
M	1045	1112	1129	1025	871
L	2090	2224	2257	2049	1742

Optical accessories: anti-glare MicroLouvre[®], honeycomb

ELECTRICAL

Supply voltage: DC24V±1.0V

Power range:

SR Blaze	Power
S	7W
M	13W
L	26W

ESD Protection: contact 4kV, air 8kV

ENVIRONMENT

Ambient temperature: -20°C ... +45°C

Storage temperature: -20°C ... +65°C

Working humidity: 5% to 85%, non-condensing

MECHANICAL

Mounting:



Material: aluminum

Housing color:



IP: IP40/IP66

LIFETIME, WARRANTY & COMPLIANCE

Warranty: 3 years

Lifetime: 30,000 hours

Compliance: CE

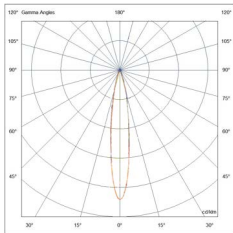
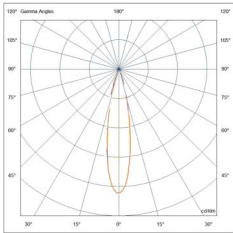
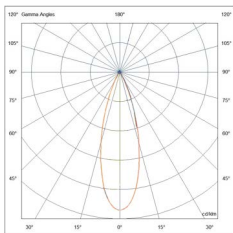
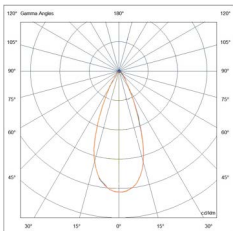
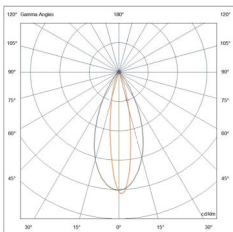

PHOTOMETRICS

930 15°		<table border="1"> <thead> <tr> <th rowspan="2">Height (m)</th> <th colspan="3">E(lx)</th> <th rowspan="2">D (m)</th> </tr> <tr> <th>S</th> <th>M</th> <th>L</th> </tr> </thead> <tbody> <tr> <td>1</td> <td>3438</td> <td>6875</td> <td>13750</td> <td>0.3</td> </tr> <tr> <td>2</td> <td>859</td> <td>1719</td> <td>3438</td> <td>0.6</td> </tr> <tr> <td>3</td> <td>382</td> <td>764</td> <td>1528</td> <td>0.9</td> </tr> <tr> <td>4</td> <td>215</td> <td>430</td> <td>859</td> <td>1.2</td> </tr> <tr> <td>5</td> <td>138</td> <td>275</td> <td>550</td> <td>1.5</td> </tr> </tbody> </table> <table border="1"> <tr> <td>I (cd)</td> <td>3596</td> <td>7191</td> <td>14383</td> </tr> </table>	Height (m)	E(lx)			D (m)	S	M	L	1	3438	6875	13750	0.3	2	859	1719	3438	0.6	3	382	764	1528	0.9	4	215	430	859	1.2	5	138	275	550	1.5	I (cd)	3596	7191	14383						
Height (m)	E(lx)			D (m)																																									
	S	M	L																																										
1	3438	6875	13750	0.3																																									
2	859	1719	3438	0.6																																									
3	382	764	1528	0.9																																									
4	215	430	859	1.2																																									
5	138	275	550	1.5																																									
I (cd)	3596	7191	14383																																										
930 20°		<table border="1"> <thead> <tr> <th rowspan="2">Height (m)</th> <th colspan="3">E(lx)</th> <th rowspan="2">D (m)</th> </tr> <tr> <th>S</th> <th>M</th> <th>L</th> </tr> </thead> <tbody> <tr> <td>1</td> <td>3028</td> <td>6417</td> <td>12833</td> <td>0.35</td> </tr> <tr> <td>2</td> <td>802</td> <td>1604</td> <td>3208</td> <td>0.70</td> </tr> <tr> <td>3</td> <td>356</td> <td>713</td> <td>1426</td> <td>1.05</td> </tr> <tr> <td>4</td> <td>201</td> <td>401</td> <td>802</td> <td>1.40</td> </tr> <tr> <td>5</td> <td>128</td> <td>257</td> <td>513</td> <td>1.75</td> </tr> </tbody> </table> <table border="1"> <tr> <td>I (cd)</td> <td>3431</td> <td>6862</td> <td>13725</td> </tr> </table>	Height (m)	E(lx)			D (m)	S	M	L	1	3028	6417	12833	0.35	2	802	1604	3208	0.70	3	356	713	1426	1.05	4	201	401	802	1.40	5	128	257	513	1.75	I (cd)	3431	6862	13725						
Height (m)	E(lx)			D (m)																																									
	S	M	L																																										
1	3028	6417	12833	0.35																																									
2	802	1604	3208	0.70																																									
3	356	713	1426	1.05																																									
4	201	401	802	1.40																																									
5	128	257	513	1.75																																									
I (cd)	3431	6862	13725																																										
930 30°		<table border="1"> <thead> <tr> <th rowspan="2">Height (m)</th> <th colspan="3">E(lx)</th> <th rowspan="2">D (m)</th> </tr> <tr> <th>S</th> <th>M</th> <th>L</th> </tr> </thead> <tbody> <tr> <td>1</td> <td>1584</td> <td>3168</td> <td>6336</td> <td>0.57</td> </tr> <tr> <td>2</td> <td>396</td> <td>792</td> <td>1584</td> <td>1.14</td> </tr> <tr> <td>3</td> <td>176</td> <td>352</td> <td>704</td> <td>1.71</td> </tr> <tr> <td>4</td> <td>99</td> <td>198</td> <td>396</td> <td>2.28</td> </tr> <tr> <td>5</td> <td>63</td> <td>127</td> <td>253</td> <td>2.85</td> </tr> </tbody> </table> <table border="1"> <tr> <td>I (cd)</td> <td>1589</td> <td>3178</td> <td>6356</td> </tr> </table>	Height (m)	E(lx)			D (m)	S	M	L	1	1584	3168	6336	0.57	2	396	792	1584	1.14	3	176	352	704	1.71	4	99	198	396	2.28	5	63	127	253	2.85	I (cd)	1589	3178	6356						
Height (m)	E(lx)			D (m)																																									
	S	M	L																																										
1	1584	3168	6336	0.57																																									
2	396	792	1584	1.14																																									
3	176	352	704	1.71																																									
4	99	198	396	2.28																																									
5	63	127	253	2.85																																									
I (cd)	1589	3178	6356																																										
930 45°		<table border="1"> <thead> <tr> <th rowspan="2">Height (m)</th> <th colspan="3">E(lx)</th> <th rowspan="2">D (m)</th> </tr> <tr> <th>S</th> <th>M</th> <th>L</th> </tr> </thead> <tbody> <tr> <td>1</td> <td>842</td> <td>1684</td> <td>3367</td> <td>0.8</td> </tr> <tr> <td>2</td> <td>210</td> <td>421</td> <td>842</td> <td>1.6</td> </tr> <tr> <td>3</td> <td>94</td> <td>187</td> <td>374</td> <td>2.4</td> </tr> <tr> <td>4</td> <td>53</td> <td>105</td> <td>210</td> <td>3.2</td> </tr> <tr> <td>5</td> <td>34</td> <td>67</td> <td>135</td> <td>4.0</td> </tr> </tbody> </table> <table border="1"> <tr> <td>I (cd)</td> <td>846</td> <td>1692</td> <td>3383</td> </tr> </table>	Height (m)	E(lx)			D (m)	S	M	L	1	842	1684	3367	0.8	2	210	421	842	1.6	3	94	187	374	2.4	4	53	105	210	3.2	5	34	67	135	4.0	I (cd)	846	1692	3383						
Height (m)	E(lx)			D (m)																																									
	S	M	L																																										
1	842	1684	3367	0.8																																									
2	210	421	842	1.6																																									
3	94	187	374	2.4																																									
4	53	105	210	3.2																																									
5	34	67	135	4.0																																									
I (cd)	846	1692	3383																																										
930 20°x40°		<table border="1"> <thead> <tr> <th rowspan="2">Height (m)</th> <th colspan="3">E(lx)</th> <th rowspan="2">D1 (m)</th> <th rowspan="2">D2 (m)</th> </tr> <tr> <th>S</th> <th>M</th> <th>L</th> </tr> </thead> <tbody> <tr> <td>1</td> <td>1256</td> <td>2513</td> <td>5025</td> <td>0.34</td> <td>0.80</td> </tr> <tr> <td>2</td> <td>314</td> <td>628</td> <td>1256</td> <td>0.68</td> <td>1.60</td> </tr> <tr> <td>3</td> <td>140</td> <td>279</td> <td>558</td> <td>1.02</td> <td>2.40</td> </tr> <tr> <td>4</td> <td>79</td> <td>157</td> <td>314</td> <td>1.36</td> <td>3.20</td> </tr> <tr> <td>5</td> <td>50</td> <td>101</td> <td>201</td> <td>1.70</td> <td>4.00</td> </tr> </tbody> </table> <table border="1"> <tr> <td>I (cd)</td> <td>1259</td> <td>2517</td> <td>5035</td> </tr> </table>	Height (m)	E(lx)			D1 (m)	D2 (m)	S	M	L	1	1256	2513	5025	0.34	0.80	2	314	628	1256	0.68	1.60	3	140	279	558	1.02	2.40	4	79	157	314	1.36	3.20	5	50	101	201	1.70	4.00	I (cd)	1259	2517	5035
Height (m)	E(lx)			D1 (m)	D2 (m)																																								
	S	M	L																																										
1	1256	2513	5025	0.34	0.80																																								
2	314	628	1256	0.68	1.60																																								
3	140	279	558	1.02	2.40																																								
4	79	157	314	1.36	3.20																																								
5	50	101	201	1.70	4.00																																								
I (cd)	1259	2517	5035																																										

DIMENSIONS

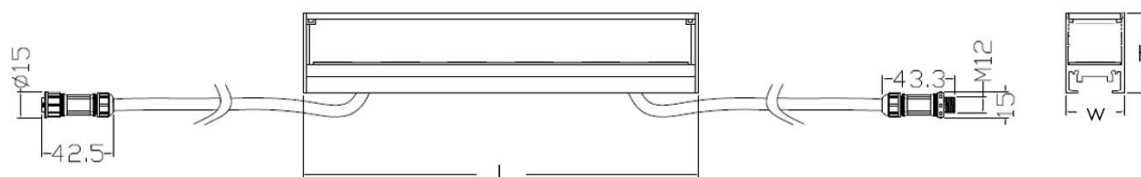

SR Blaze	h (mm)	w (mm)	l (mm)
S	48	35	236
M			476
L			956

OPTICAL ACCESSORIES

anti-glare MicroLouvre® (MLV)



honeycomb (HC)



MOUNTING OPTIONS

surface mount (SFM)



adjustable bracket (ADJ)



magnetic mount (MAG)



WIRING

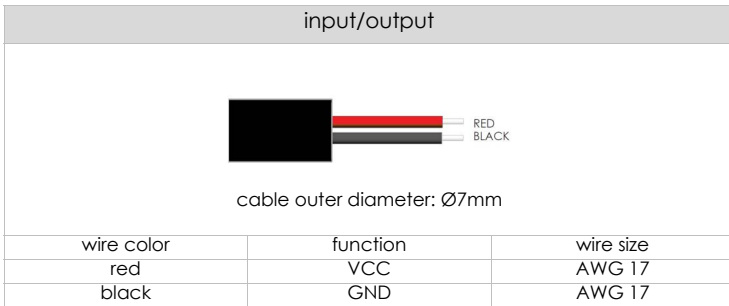

CONNECTIONS

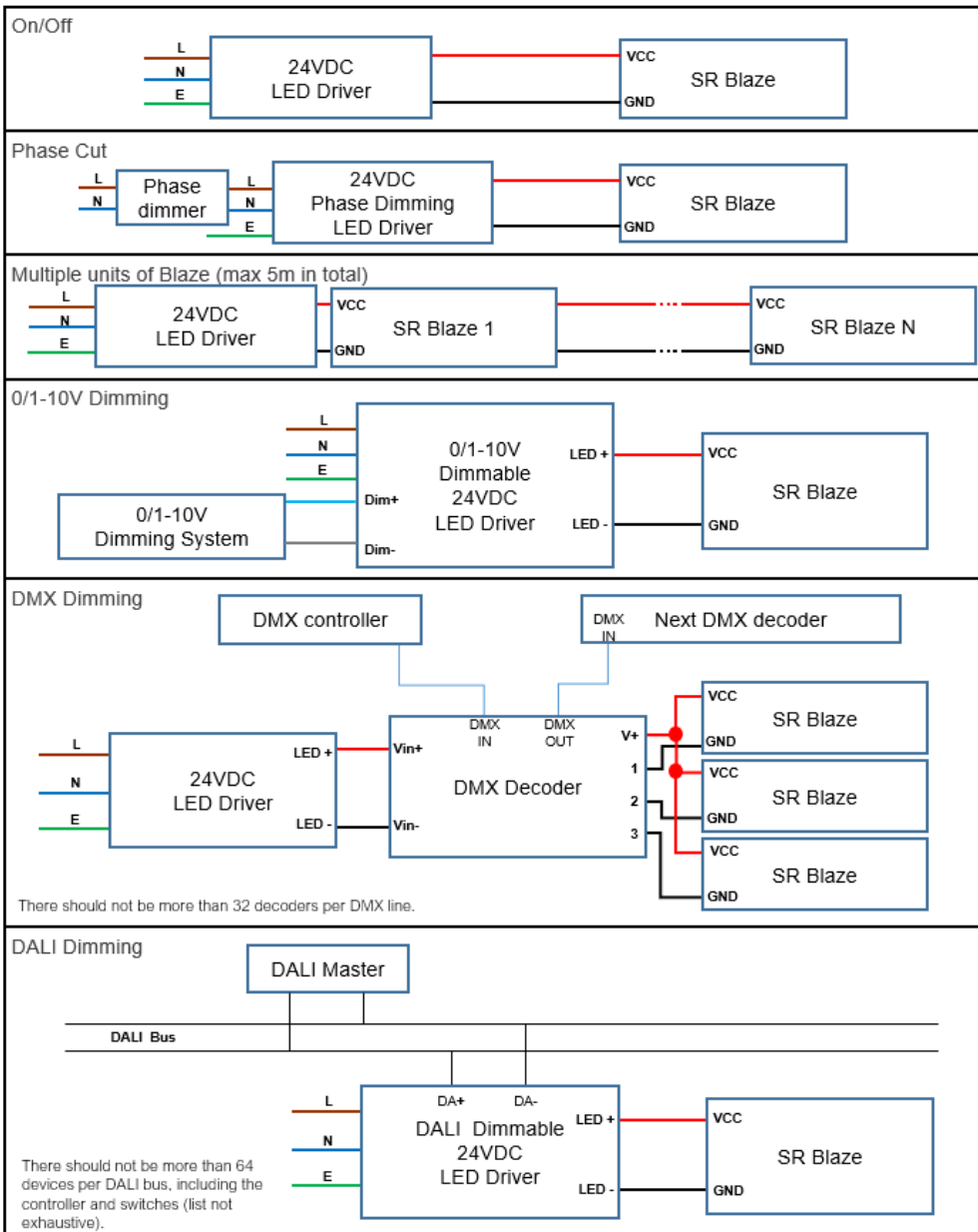

SR Linear Light BLAZE SERIES



ORDERING INFORMATION

SR Blaze Outdoor Series	Model	Power	CRI/CCT	Beam Angle ^	Housing Color *	IP	Optical Accessories#	Cabling†	Mounting‡
SRBLAZE	S	7W	927 930 935 940	NRB MDB WDB FLD ELL	B W	66	HC MLV NA	INC IOC	SFM ADJ MAG
	M	13W	950 827 830 835						
	L	26W	840 850						

Example: SRBLAZE-S-7W-930-10X60D-B-66-NA-INC-SFM refers to SR Linear Light Blaze Outdoor Series, S model, 7W, CRI Ra90+, CCT 3000K, beam angle 20°x40°, IP66, input with connector and surface mounting.

SR Blaze Indoor Series	Model	Power	CRI/CCT	Beam Angle ^	Housing Color *	IP	Optical Accessories#	Cabling†	Mounting‡
SRBLAZE	S	7W	927 930 935 940	NRB MDB WDB FLD ELL	B W	40	HC MLV NA	INBW IOBW	SFM ADJ MAG
	M	13W	950 827 830 835						
	L	26W	840 850						

Example: SRBLAZE-S-7W-930-WDB-B-40-NA-INBW-MAG refers to SR Linear Light Blaze Indoor Series, S model, 7W, CRI Ra90+, CCT 3000K, beam angle 30°, IP40, input with bare wire and magnetic catch mounting.

Beam Angle ^	Description
NRB	15°
MDB	20°
WDB	30°
FLD	45°
ELL	20°x40°

Cabling Options†	Description
INBW	input with bare wires (300mm)
INC	input with male connector
IOBW	input and output with bare wires (300mm)
IOC	input with male connector and output with female connector

Housing Color Options *	Color Description
B	black
W	white

Mounting‡	Description
SFM	surface mount
ADJ	adjustable bracket
MAG	magnetic mount

Optical Accessories†	Description
HC	honeycomb
MLV	anti-glare MicroLouvre®
NA	no accessory

Accessories	Description
SRBLAZE STARTER 1M	starter cable (1m) with female connector
SRBLAZE EX 1M	extension cable (1m) with 1x male and 1x female connectors

LED Drivers	Description
SAV-060N024X02HQA	60W 24V Constant Voltage LED Driver
SAV-096N024X400Q	96W 24V Constant Voltage LED Driver
SAV-150N024X625Q	150W 24V Constant Voltage LED Driver

Note: System design will vary depending on actual project configuration. Please consult your local sales support for details in length in series connection, connecting cable type and lengths.

Disclaimer: Data might vary due to equipment tolerance. Manufacturer reserves the right to make changes to information published in this document, including without limitation specifications and product descriptions, at any time and without notice.