



SR Downlight

RYKO SERIES



SUMMARY

dimension S: Ø63mm M: Ø90mm L: Ø115mm XL: Ø140mm	cut out S: Ø55mm M: Ø80mm L: Ø105mm XL: Ø130mm	adjustable 30°	trim W B	reflector W B MIR DRM
IP IP40	power S: 7W 9W M: 9W 13W 15W L: 15W 21W 26W XL: 26W 30W 38W	beam NDB: ≤20° MDB: 21° - 29° WDB: 30° - 45° FLD: ≥46°	color 2700K 3000K 4000K	CRI Ra 90+

FEATURES

- Simple and elegant recessed mounting fixed and adjustable downlight series
- Bottom removable for easy installation and maintenance
- Wide range of beam angle selections, power options and flux outputs to achieve target lighting scenarios
- Plaster ring technologies for different ceiling thickness

DRIVERS



LIGHT OUTPUT

Light source: Bridgelux COB

CRI/CCT: 927, 930, 940

Light distribution: symmetric

Luminaire Lumen Output:

SR Ryko	Power (W)	Beam Angle	Flux (lm) @930
S	7	18°	314
		24°	363
		35°	460
	9	49°	477
		18°	391
		24°	493
M	9	35°	572
		49°	592
		18°	673
	13	28°	638
		35°	667
		56°	716
		18°	1009
		28°	921
		35°	945
	15	56°	901
		18°	1175
		28°	1018
35°		1066	
56°		1100	
20°		942	
L	15	29°	1088
		39°	1123
		50°	1031
	21	20°	1245
		29°	1424
		39°	1538
		50°	1300
		20°	1705
		29°	1629
	26	39°	1733
		50°	1569
		24°	1986
42°		2074	
55°		2166	
XL		26	24°
	42°		2536
	55°		2929
	30	24°	2933
		42°	3088
		55°	3240
	38	24°	2933
		42°	3088
		55°	3240

ELECTRICAL

System power, supply current and voltage:

SR Ryko	W	mA	V(typ)
S	7	150	36
	9	200	
M	9	200	
	13	300	
	15	350	
L	15	350	
	21	500	
	26	600	
XL	26	600	
	30	700	
	38	900	

MECHANICAL

IP: IP40

Cut out: Ø55/80/105/130mm

Mounting: ceiling recessed

Material: aluminum die cast

Horizontal rotation: 355°

Adjustable angle: 30°

Color:

housing/trim	reflector
W B	W B MIR DRM

LIFETIME, WARRANTY & COMPLIANCE

Warranty: 3 years

Lifetime: 30,000 hours, L70/B50 at ta 35°C

Compliance: CE

Optical accessories: honeycomb, frosted lens

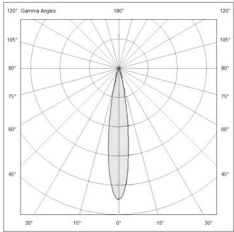
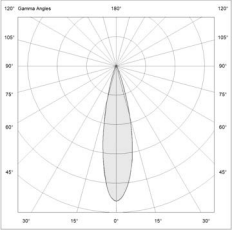
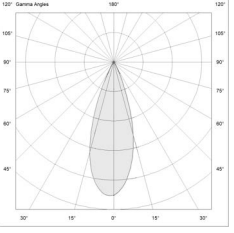
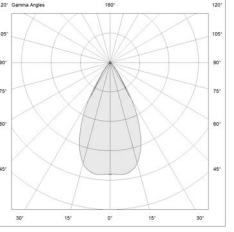
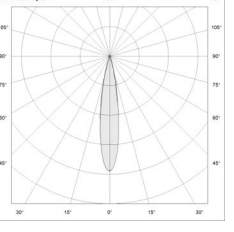
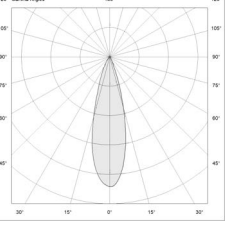

PHOTOMETRY

S 930 18°		<table border="1"> <thead> <tr> <th rowspan="2">Height (m)</th> <th colspan="2">E (lx)</th> <th rowspan="2">D (m)</th> </tr> <tr> <th>7W</th> <th>9W</th> </tr> </thead> <tbody> <tr> <td>1</td> <td>2180</td> <td>2657</td> <td>0.32</td> </tr> <tr> <td>2</td> <td>545</td> <td>664</td> <td>0.64</td> </tr> <tr> <td>3</td> <td>242</td> <td>295</td> <td>0.95</td> </tr> <tr> <td>4</td> <td>136</td> <td>166</td> <td>1.27</td> </tr> <tr> <td>5</td> <td>87</td> <td>106</td> <td>1.59</td> </tr> <tr> <td>I (cd)</td> <td>2268</td> <td>2689</td> <td></td> </tr> </tbody> </table>	Height (m)	E (lx)		D (m)	7W	9W	1	2180	2657	0.32	2	545	664	0.64	3	242	295	0.95	4	136	166	1.27	5	87	106	1.59	I (cd)	2268	2689									
Height (m)	E (lx)			D (m)																																				
	7W	9W																																						
1	2180	2657	0.32																																					
2	545	664	0.64																																					
3	242	295	0.95																																					
4	136	166	1.27																																					
5	87	106	1.59																																					
I (cd)	2268	2689																																						
S 930 24°		<table border="1"> <thead> <tr> <th rowspan="2">Height (m)</th> <th colspan="2">E (lx)</th> <th rowspan="2">D (m)</th> </tr> <tr> <th>7W</th> <th>9W</th> </tr> </thead> <tbody> <tr> <td>1</td> <td>1745</td> <td>2244</td> <td>0.43</td> </tr> <tr> <td>2</td> <td>436</td> <td>561</td> <td>0.85</td> </tr> <tr> <td>3</td> <td>194</td> <td>249</td> <td>1.28</td> </tr> <tr> <td>4</td> <td>109</td> <td>140</td> <td>1.70</td> </tr> <tr> <td>5</td> <td>70</td> <td>90</td> <td>2.13</td> </tr> <tr> <td>I (cd)</td> <td>1766</td> <td>2248</td> <td></td> </tr> </tbody> </table>	Height (m)	E (lx)		D (m)	7W	9W	1	1745	2244	0.43	2	436	561	0.85	3	194	249	1.28	4	109	140	1.70	5	70	90	2.13	I (cd)	1766	2248									
Height (m)	E (lx)			D (m)																																				
	7W	9W																																						
1	1745	2244	0.43																																					
2	436	561	0.85																																					
3	194	249	1.28																																					
4	109	140	1.70																																					
5	70	90	2.13																																					
I (cd)	1766	2248																																						
S 930 35°		<table border="1"> <thead> <tr> <th rowspan="2">Height (m)</th> <th colspan="2">E (lx)</th> <th rowspan="2">D (m)</th> </tr> <tr> <th>7W</th> <th>9W</th> </tr> </thead> <tbody> <tr> <td>1</td> <td>1228</td> <td>1519</td> <td>0.64</td> </tr> <tr> <td>2</td> <td>307</td> <td>380</td> <td>1.27</td> </tr> <tr> <td>3</td> <td>136</td> <td>169</td> <td>1.91</td> </tr> <tr> <td>4</td> <td>77</td> <td>95</td> <td>2.54</td> </tr> <tr> <td>5</td> <td>49</td> <td>61</td> <td>3.18</td> </tr> <tr> <td>I (cd)</td> <td>1248</td> <td>1546</td> <td></td> </tr> </tbody> </table>	Height (m)	E (lx)		D (m)	7W	9W	1	1228	1519	0.64	2	307	380	1.27	3	136	169	1.91	4	77	95	2.54	5	49	61	3.18	I (cd)	1248	1546									
Height (m)	E (lx)			D (m)																																				
	7W	9W																																						
1	1228	1519	0.64																																					
2	307	380	1.27																																					
3	136	169	1.91																																					
4	77	95	2.54																																					
5	49	61	3.18																																					
I (cd)	1248	1546																																						
S 930 49°		<table border="1"> <thead> <tr> <th rowspan="2">Height (m)</th> <th colspan="2">E (lx)</th> <th rowspan="2">D (m)</th> </tr> <tr> <th>7W</th> <th>9W</th> </tr> </thead> <tbody> <tr> <td>1</td> <td>647</td> <td>801</td> <td>0.92</td> </tr> <tr> <td>2</td> <td>162</td> <td>200</td> <td>1.83</td> </tr> <tr> <td>3</td> <td>72</td> <td>89</td> <td>2.75</td> </tr> <tr> <td>4</td> <td>40</td> <td>50</td> <td>3.66</td> </tr> <tr> <td>5</td> <td>26</td> <td>32</td> <td>4.58</td> </tr> <tr> <td>I (cd)</td> <td>698</td> <td>865</td> <td></td> </tr> </tbody> </table>	Height (m)	E (lx)		D (m)	7W	9W	1	647	801	0.92	2	162	200	1.83	3	72	89	2.75	4	40	50	3.66	5	26	32	4.58	I (cd)	698	865									
Height (m)	E (lx)			D (m)																																				
	7W	9W																																						
1	647	801	0.92																																					
2	162	200	1.83																																					
3	72	89	2.75																																					
4	40	50	3.66																																					
5	26	32	4.58																																					
I (cd)	698	865																																						
M 930 18°		<table border="1"> <thead> <tr> <th rowspan="2">Height (m)</th> <th colspan="3">E (lx)</th> <th rowspan="2">D (m)</th> </tr> <tr> <th>9W</th> <th>13W</th> <th>15W</th> </tr> </thead> <tbody> <tr> <td>1</td> <td>4551</td> <td>7335</td> <td>8557</td> <td>0.31</td> </tr> <tr> <td>2</td> <td>1138</td> <td>1834</td> <td>2139</td> <td>0.62</td> </tr> <tr> <td>3</td> <td>506</td> <td>815</td> <td>951</td> <td>0.94</td> </tr> <tr> <td>4</td> <td>284</td> <td>458</td> <td>535</td> <td>1.25</td> </tr> <tr> <td>5</td> <td>182</td> <td>293</td> <td>342</td> <td>1.56</td> </tr> <tr> <td>I (cd)</td> <td>4571</td> <td>7367</td> <td>8594</td> <td></td> </tr> </tbody> </table>	Height (m)	E (lx)			D (m)	9W	13W	15W	1	4551	7335	8557	0.31	2	1138	1834	2139	0.62	3	506	815	951	0.94	4	284	458	535	1.25	5	182	293	342	1.56	I (cd)	4571	7367	8594	
Height (m)	E (lx)			D (m)																																				
	9W	13W	15W																																					
1	4551	7335	8557	0.31																																				
2	1138	1834	2139	0.62																																				
3	506	815	951	0.94																																				
4	284	458	535	1.25																																				
5	182	293	342	1.56																																				
I (cd)	4571	7367	8594																																					
M 930 28°		<table border="1"> <thead> <tr> <th rowspan="2">Height (m)</th> <th colspan="3">E (lx)</th> <th rowspan="2">D (m)</th> </tr> <tr> <th>9W</th> <th>13W</th> <th>15W</th> </tr> </thead> <tbody> <tr> <td>1</td> <td>2211</td> <td>3097</td> <td>3373</td> <td>0.49</td> </tr> <tr> <td>2</td> <td>553</td> <td>774</td> <td>843</td> <td>0.99</td> </tr> <tr> <td>3</td> <td>246</td> <td>344</td> <td>375</td> <td>1.48</td> </tr> <tr> <td>4</td> <td>138</td> <td>194</td> <td>211</td> <td>1.98</td> </tr> <tr> <td>5</td> <td>88</td> <td>124</td> <td>135</td> <td>2.47</td> </tr> <tr> <td>I (cd)</td> <td>2234</td> <td>3130</td> <td>3378</td> <td></td> </tr> </tbody> </table>	Height (m)	E (lx)			D (m)	9W	13W	15W	1	2211	3097	3373	0.49	2	553	774	843	0.99	3	246	344	375	1.48	4	138	194	211	1.98	5	88	124	135	2.47	I (cd)	2234	3130	3378	
Height (m)	E (lx)			D (m)																																				
	9W	13W	15W																																					
1	2211	3097	3373	0.49																																				
2	553	774	843	0.99																																				
3	246	344	375	1.48																																				
4	138	194	211	1.98																																				
5	88	124	135	2.47																																				
I (cd)	2234	3130	3378																																					

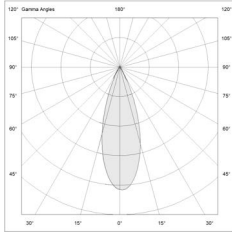
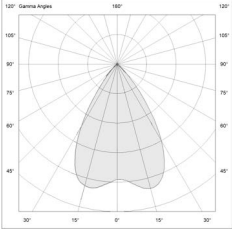
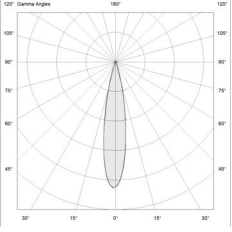
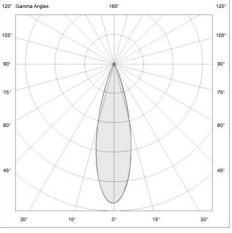
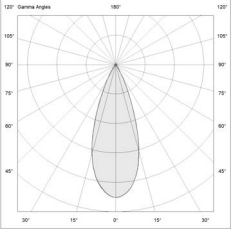
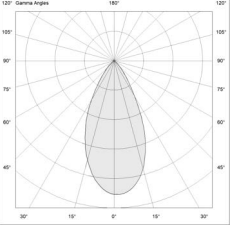
M 930 35°		<table border="1"> <thead> <tr> <th rowspan="2">Height (m)</th> <th colspan="3">E (lx)</th> <th rowspan="2">D (m)</th> </tr> <tr> <th>9W</th> <th>13W</th> <th>15W</th> </tr> </thead> <tbody> <tr> <td>1</td> <td>1657</td> <td>2390</td> <td>2695</td> <td>0.62</td> </tr> <tr> <td>2</td> <td>414</td> <td>597</td> <td>674</td> <td>1.24</td> </tr> <tr> <td>3</td> <td>184</td> <td>266</td> <td>299</td> <td>1.87</td> </tr> <tr> <td>4</td> <td>104</td> <td>149</td> <td>168</td> <td>2.49</td> </tr> <tr> <td>5</td> <td>66</td> <td>96</td> <td>108</td> <td>3.11</td> </tr> <tr> <td>I (cd)</td> <td>1684</td> <td>2409</td> <td>2721</td> <td></td> </tr> </tbody> </table>	Height (m)	E (lx)			D (m)	9W	13W	15W	1	1657	2390	2695	0.62	2	414	597	674	1.24	3	184	266	299	1.87	4	104	149	168	2.49	5	66	96	108	3.11	I (cd)	1684	2409	2721	
Height (m)	E (lx)			D (m)																																				
	9W	13W	15W																																					
1	1657	2390	2695	0.62																																				
2	414	597	674	1.24																																				
3	184	266	299	1.87																																				
4	104	149	168	2.49																																				
5	66	96	108	3.11																																				
I (cd)	1684	2409	2721																																					
M 930 56°		<table border="1"> <thead> <tr> <th rowspan="2">Height (m)</th> <th colspan="3">E (lx)</th> <th rowspan="2">D (m)</th> </tr> <tr> <th>9W</th> <th>13W</th> <th>15W</th> </tr> </thead> <tbody> <tr> <td>1</td> <td>587</td> <td>796</td> <td>1039</td> <td>1.15</td> </tr> <tr> <td>2</td> <td>147</td> <td>199</td> <td>260</td> <td>2.30</td> </tr> <tr> <td>3</td> <td>65</td> <td>88</td> <td>115</td> <td>3.45</td> </tr> <tr> <td>4</td> <td>37</td> <td>50</td> <td>65</td> <td>4.60</td> </tr> <tr> <td>5</td> <td>23</td> <td>32</td> <td>42</td> <td>5.75</td> </tr> <tr> <td>I (cd)</td> <td>728</td> <td>917</td> <td>1294</td> <td></td> </tr> </tbody> </table>	Height (m)	E (lx)			D (m)	9W	13W	15W	1	587	796	1039	1.15	2	147	199	260	2.30	3	65	88	115	3.45	4	37	50	65	4.60	5	23	32	42	5.75	I (cd)	728	917	1294	
Height (m)	E (lx)			D (m)																																				
	9W	13W	15W																																					
1	587	796	1039	1.15																																				
2	147	199	260	2.30																																				
3	65	88	115	3.45																																				
4	37	50	65	4.60																																				
5	23	32	42	5.75																																				
I (cd)	728	917	1294																																					
L 930 20°		<table border="1"> <thead> <tr> <th rowspan="2">Height (m)</th> <th colspan="3">E (lx)</th> <th rowspan="2">D (m)</th> </tr> <tr> <th>15W</th> <th>21W</th> <th>26W</th> </tr> </thead> <tbody> <tr> <td>1</td> <td>5978</td> <td>6563</td> <td>8810</td> <td>0.38</td> </tr> <tr> <td>2</td> <td>1494</td> <td>1641</td> <td>2202</td> <td>0.76</td> </tr> <tr> <td>3</td> <td>664</td> <td>729</td> <td>979</td> <td>1.14</td> </tr> <tr> <td>4</td> <td>374</td> <td>410</td> <td>551</td> <td>1.52</td> </tr> <tr> <td>5</td> <td>239</td> <td>263</td> <td>352</td> <td>1.90</td> </tr> <tr> <td>I (cd)</td> <td>cd</td> <td>6027</td> <td>6664</td> <td></td> </tr> </tbody> </table>	Height (m)	E (lx)			D (m)	15W	21W	26W	1	5978	6563	8810	0.38	2	1494	1641	2202	0.76	3	664	729	979	1.14	4	374	410	551	1.52	5	239	263	352	1.90	I (cd)	cd	6027	6664	
Height (m)	E (lx)			D (m)																																				
	15W	21W	26W																																					
1	5978	6563	8810	0.38																																				
2	1494	1641	2202	0.76																																				
3	664	729	979	1.14																																				
4	374	410	551	1.52																																				
5	239	263	352	1.90																																				
I (cd)	cd	6027	6664																																					
L 930 29°		<table border="1"> <thead> <tr> <th rowspan="2">Height (m)</th> <th colspan="3">E (lx)</th> <th rowspan="2">D (m)</th> </tr> <tr> <th>15W</th> <th>21W</th> <th>26W</th> </tr> </thead> <tbody> <tr> <td>1</td> <td>4116</td> <td>4942</td> <td>5625</td> <td>0.51</td> </tr> <tr> <td>2</td> <td>1029</td> <td>1235</td> <td>1406</td> <td>1.03</td> </tr> <tr> <td>3</td> <td>457</td> <td>549</td> <td>625</td> <td>1.54</td> </tr> <tr> <td>4</td> <td>257</td> <td>309</td> <td>352</td> <td>2.06</td> </tr> <tr> <td>5</td> <td>165</td> <td>198</td> <td>225</td> <td>2.57</td> </tr> <tr> <td>I (cd)</td> <td>4124</td> <td>5067</td> <td>5944</td> <td></td> </tr> </tbody> </table>	Height (m)	E (lx)			D (m)	15W	21W	26W	1	4116	4942	5625	0.51	2	1029	1235	1406	1.03	3	457	549	625	1.54	4	257	309	352	2.06	5	165	198	225	2.57	I (cd)	4124	5067	5944	
Height (m)	E (lx)			D (m)																																				
	15W	21W	26W																																					
1	4116	4942	5625	0.51																																				
2	1029	1235	1406	1.03																																				
3	457	549	625	1.54																																				
4	257	309	352	2.06																																				
5	165	198	225	2.57																																				
I (cd)	4124	5067	5944																																					
L 930 39°		<table border="1"> <thead> <tr> <th rowspan="2">Height (m)</th> <th colspan="3">E (lx)</th> <th rowspan="2">D (m)</th> </tr> <tr> <th>15W</th> <th>21W</th> <th>26W</th> </tr> </thead> <tbody> <tr> <td>1</td> <td>2534</td> <td>3163</td> <td>3781.8</td> <td>0.70</td> </tr> <tr> <td>2</td> <td>634</td> <td>791</td> <td>945</td> <td>1.40</td> </tr> <tr> <td>3</td> <td>282</td> <td>351</td> <td>420</td> <td>2.10</td> </tr> <tr> <td>4</td> <td>158</td> <td>198</td> <td>236</td> <td>2.80</td> </tr> <tr> <td>5</td> <td>101</td> <td>127</td> <td>151</td> <td>3.51</td> </tr> <tr> <td>I (cd)</td> <td>2540</td> <td>3233</td> <td>3825</td> <td></td> </tr> </tbody> </table>	Height (m)	E (lx)			D (m)	15W	21W	26W	1	2534	3163	3781.8	0.70	2	634	791	945	1.40	3	282	351	420	2.10	4	158	198	236	2.80	5	101	127	151	3.51	I (cd)	2540	3233	3825	
Height (m)	E (lx)			D (m)																																				
	15W	21W	26W																																					
1	2534	3163	3781.8	0.70																																				
2	634	791	945	1.40																																				
3	282	351	420	2.10																																				
4	158	198	236	2.80																																				
5	101	127	151	3.51																																				
I (cd)	2540	3233	3825																																					
L 930 50°		<table border="1"> <thead> <tr> <th rowspan="2">Height (m)</th> <th colspan="3">E (lx)</th> <th rowspan="2">D (m)</th> </tr> <tr> <th>15W</th> <th>21W</th> <th>26W</th> </tr> </thead> <tbody> <tr> <td>1</td> <td>1403</td> <td>1735</td> <td>2192.1</td> <td>0.92</td> </tr> <tr> <td>2</td> <td>351</td> <td>434</td> <td>548</td> <td>1.85</td> </tr> <tr> <td>3</td> <td>156</td> <td>193</td> <td>244</td> <td>2.77</td> </tr> <tr> <td>4</td> <td>88</td> <td>108</td> <td>137</td> <td>3.70</td> </tr> <tr> <td>5</td> <td>56</td> <td>69</td> <td>88</td> <td>4.62</td> </tr> <tr> <td>I (cd)</td> <td>1407</td> <td>1777</td> <td>2205</td> <td></td> </tr> </tbody> </table>	Height (m)	E (lx)			D (m)	15W	21W	26W	1	1403	1735	2192.1	0.92	2	351	434	548	1.85	3	156	193	244	2.77	4	88	108	137	3.70	5	56	69	88	4.62	I (cd)	1407	1777	2205	
Height (m)	E (lx)			D (m)																																				
	15W	21W	26W																																					
1	1403	1735	2192.1	0.92																																				
2	351	434	548	1.85																																				
3	156	193	244	2.77																																				
4	88	108	137	3.70																																				
5	56	69	88	4.62																																				
I (cd)	1407	1777	2205																																					



<p>XL 930 24°</p>		<table border="1"> <thead> <tr> <th rowspan="2">Height (m)</th> <th colspan="3">E (lx)</th> <th rowspan="2">D (m)</th> </tr> <tr> <th>25W</th> <th>30W</th> <th>38W</th> </tr> </thead> <tbody> <tr> <td>1</td> <td>9016</td> <td>11503</td> <td>12835</td> <td>0.42</td> </tr> <tr> <td>2</td> <td>2254</td> <td>2876</td> <td>3209</td> <td>0.83</td> </tr> <tr> <td>3</td> <td>1002</td> <td>1278</td> <td>1426</td> <td>1.25</td> </tr> <tr> <td>4</td> <td>563</td> <td>719</td> <td>802</td> <td>1.67</td> </tr> <tr> <td>5</td> <td>361</td> <td>460</td> <td>513</td> <td>2.09</td> </tr> <tr> <td>I (cd)</td> <td>9056</td> <td>11794</td> <td>12965</td> <td></td> </tr> </tbody> </table>	Height (m)	E (lx)			D (m)	25W	30W	38W	1	9016	11503	12835	0.42	2	2254	2876	3209	0.83	3	1002	1278	1426	1.25	4	563	719	802	1.67	5	361	460	513	2.09	I (cd)	9056	11794	12965	
Height (m)	E (lx)			D (m)																																				
	25W	30W	38W																																					
1	9016	11503	12835	0.42																																				
2	2254	2876	3209	0.83																																				
3	1002	1278	1426	1.25																																				
4	563	719	802	1.67																																				
5	361	460	513	2.09																																				
I (cd)	9056	11794	12965																																					
<p>XL 930 42°</p>		<table border="1"> <thead> <tr> <th rowspan="2">Height (m)</th> <th colspan="3">E (lx)</th> <th rowspan="2">D (m)</th> </tr> <tr> <th>25W</th> <th>30W</th> <th>38W</th> </tr> </thead> <tbody> <tr> <td>1</td> <td>4175</td> <td>4858</td> <td>6221.4</td> <td>0.76</td> </tr> <tr> <td>2</td> <td>1044</td> <td>1215</td> <td>1555</td> <td>1.52</td> </tr> <tr> <td>3</td> <td>464</td> <td>540</td> <td>691</td> <td>2.27</td> </tr> <tr> <td>4</td> <td>261</td> <td>304</td> <td>389</td> <td>3.03</td> </tr> <tr> <td>5</td> <td>167</td> <td>194</td> <td>249</td> <td>3.79</td> </tr> <tr> <td>I (cd)</td> <td>4200</td> <td>4922</td> <td>6286</td> <td></td> </tr> </tbody> </table>	Height (m)	E (lx)			D (m)	25W	30W	38W	1	4175	4858	6221.4	0.76	2	1044	1215	1555	1.52	3	464	540	691	2.27	4	261	304	389	3.03	5	167	194	249	3.79	I (cd)	4200	4922	6286	
Height (m)	E (lx)			D (m)																																				
	25W	30W	38W																																					
1	4175	4858	6221.4	0.76																																				
2	1044	1215	1555	1.52																																				
3	464	540	691	2.27																																				
4	261	304	389	3.03																																				
5	167	194	249	3.79																																				
I (cd)	4200	4922	6286																																					
<p>XL 930 55°</p>		<table border="1"> <thead> <tr> <th rowspan="2">Height (m)</th> <th colspan="3">E (lx)</th> <th rowspan="2">D (m)</th> </tr> <tr> <th>25W</th> <th>30W</th> <th>38W</th> </tr> </thead> <tbody> <tr> <td>1</td> <td>2505</td> <td>3182</td> <td>3775.9</td> <td>1.05</td> </tr> <tr> <td>2</td> <td>626</td> <td>795</td> <td>944</td> <td>2.10</td> </tr> <tr> <td>3</td> <td>278</td> <td>354</td> <td>420</td> <td>3.15</td> </tr> <tr> <td>4</td> <td>157</td> <td>199</td> <td>236</td> <td>4.19</td> </tr> <tr> <td>5</td> <td>100</td> <td>127</td> <td>151</td> <td>5.24</td> </tr> <tr> <td>I (cd)</td> <td>2521</td> <td>3203</td> <td>3838</td> <td></td> </tr> </tbody> </table>	Height (m)	E (lx)			D (m)	25W	30W	38W	1	2505	3182	3775.9	1.05	2	626	795	944	2.10	3	278	354	420	3.15	4	157	199	236	4.19	5	100	127	151	5.24	I (cd)	2521	3203	3838	
Height (m)	E (lx)			D (m)																																				
	25W	30W	38W																																					
1	2505	3182	3775.9	1.05																																				
2	626	795	944	2.10																																				
3	278	354	420	3.15																																				
4	157	199	236	4.19																																				
5	100	127	151	5.24																																				
I (cd)	2521	3203	3838																																					

DIMENSION

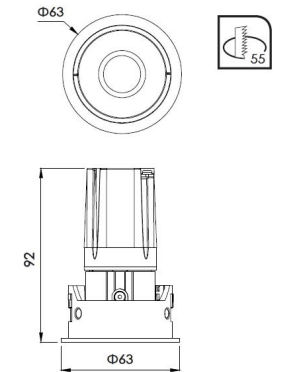
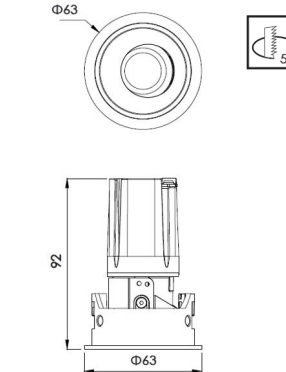
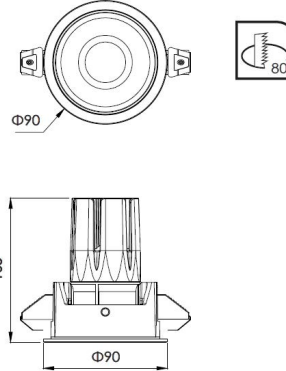
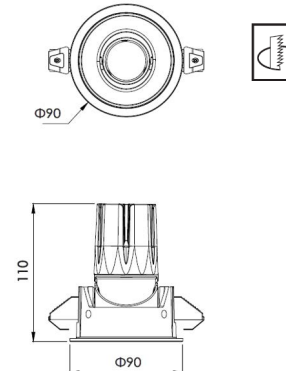
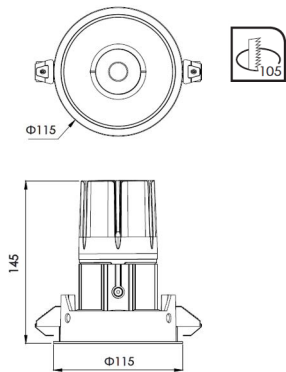
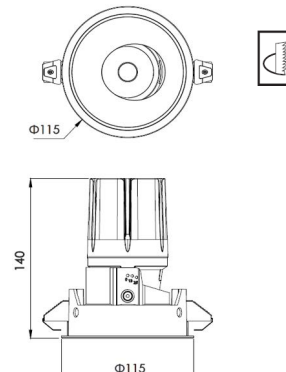
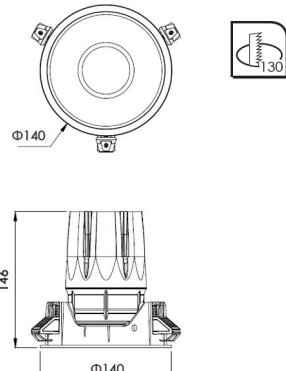
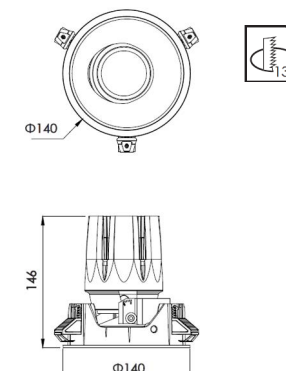
<p>RYKO S</p>		<p>RYKO D S</p>	
<p>RYKO M</p>		<p>RYKO D M</p>	
<p>RYKO L</p>		<p>RYKO D L</p>	
<p>RYKO XL</p>		<p>RYKO D XL</p>	



CONNECTION

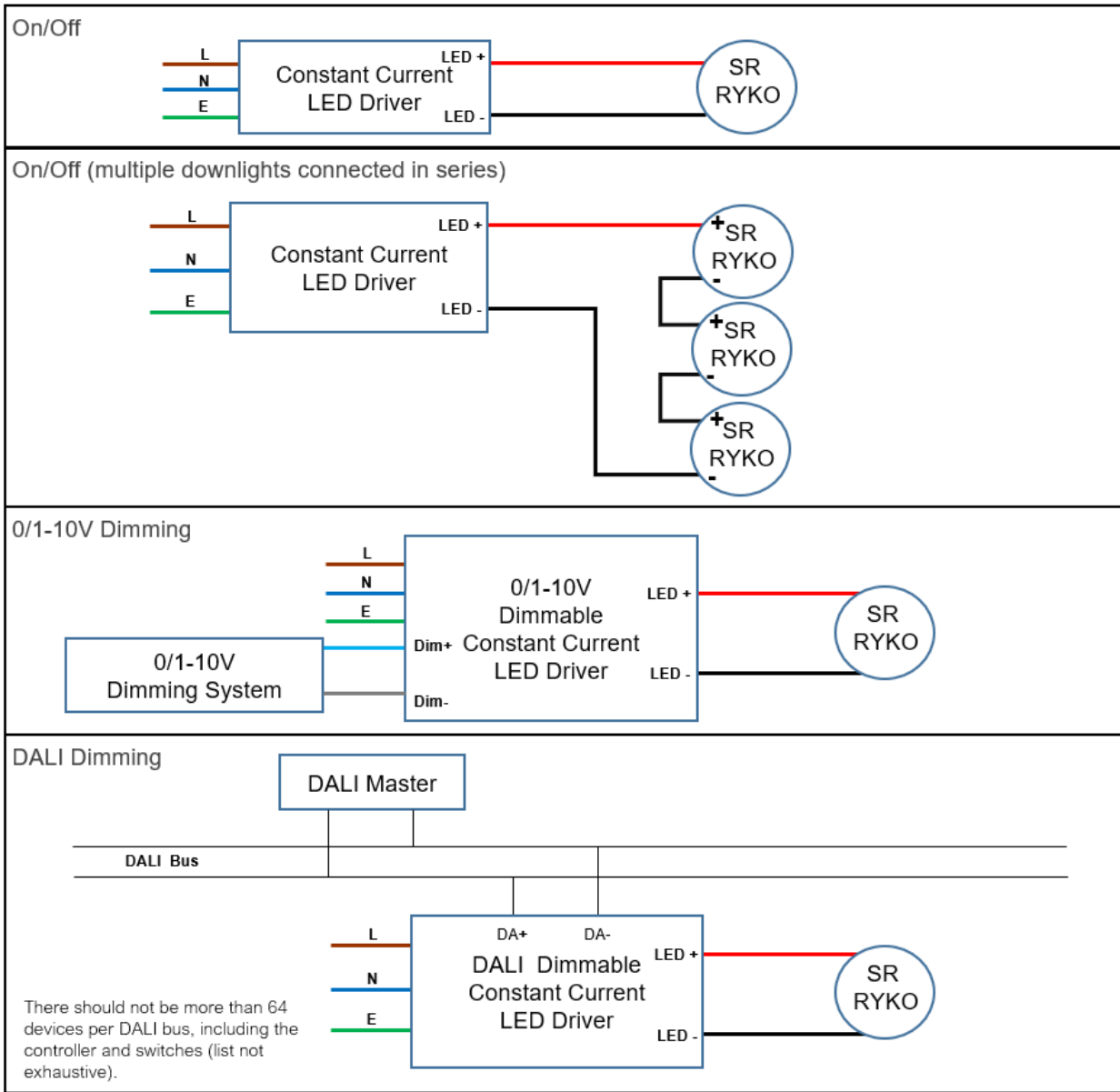

Consult your local sales team for other control protocols, e.g., DMX.

SR DOWNLIGHT RYKO SERIES



ORDERING INFORMATION

SR Downlight ^	Model	CRI/CCT	Beam Angle*	Trim Color †	Reflector Color †	Accessory‡
SRRYKO	S	927	NRB	W B	W B MIR DRM	NA HC FRO
SRRYKOD	M L XL	930 940	MDB WDB FLD			

Example: SRRYKO S 930 MDB W W NA refers to SR ID DL Ryko S Series, CRI Ra90+, CCT 3000K, beam angle 24°, white trim finishing with white reflector.

SR Downlight ^	Description
SRRYKO	SR Ryko Fixed Downlight
SRRYKOD	SR Ryko Adjustable Downlight

Beam Angle Ordering Code *	Beam Angle			
	S	M	L	XL
NRB	18°	18°	20°	--
MDB	24°	28°	29°	24°
WDB	35°	35°	39°	42°
FLD	49°	56°	50°	55°

Trim and Reflector Color Options †	Color Description
B	black
W	white
MIR	mirror
DRM	dark mirror

Accessory ‡	Description
NA	no accessory
HC	honeycomb
FRO	frosted lens

Disclaimer: Data might vary due to equipment tolerance. Manufacturer reserves the right to make changes to information published in this document, including without limitation specifications and product descriptions, at any time and without notice.