



SR ID DL

## DYNA SERIES



### SUMMARY

dimension Ø86mm	height MX9: 88mm MX11: 115mm MX15: 123mm	cut out 75mm	trim W B	reflector W B DRM MIR
IP IP40 IP65	power MX9 MX11 MX15	beam 13° 24° 38° 55°	color 	CRI Ra90+ Ra80+

### FEATURES

- Sleek and elegant recessed mounting downlight
- Easy installation and maintenance with modular system design
- Wide range of beam angle selections: 13°/24°/38°/55°
- Available in IP40 or IP65
- Long lifetime, 50,000 hours
- Honeycomb, spread lens and anti-glare snoot accessory options

### DIMMING



### ELECTRICAL

Supply voltage: 220-240V~

System power, total supply current and voltage to MX:

SR ID DL	Modular X	Beam angle	W	mA	V(typ)*
Dyna Series	MX9	13°	7	180	30
	MX11		9	250	
	MX15		13	350	
	MX9	all other beam angles	9	180	36
	MX11		11	250	
	MX15		15	350	

### MECHANICAL

IIP: IP40/IP65

Cut out: Ø75mm

Mounting: ceiling recessed

Material: aluminum die cast

Color:

housing/trim	reflector
W B	W B DRM MIR

### LIFETIME, WARRANTY & COMPLIANCE

Warranty: 3 years

Lifetime: 50,000 hours

Compliance: CE

Operating temperature: -20...+45°C

### LIGHT OUTPUT

Light source: Citizen COB

CRI/CCT: 927, 930, 940, 827, 830, 840, 850

Light distribution: symmetric

Beam angle: 13°/24°/38°/55°

Luminaire Lumen Output:

SR ID DL	Modular X	Beam Angle	Flux (lm)		
			927	930	940
Dyna Series	MX9	13°	378	400	435
		24°	440	459	473
		38°	420	442	487
		55°	420	442	487
	MX11	13°	468	496	540
		24°	583	608	627
		38°	556	585	646
		55°	562	592	653
	MX15	13°	624	661	719
		24°	861	899	927
		38°	819	862	950
		55°	815	858	946

### Optical accessories:

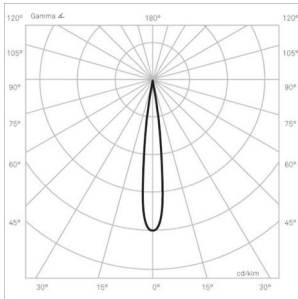
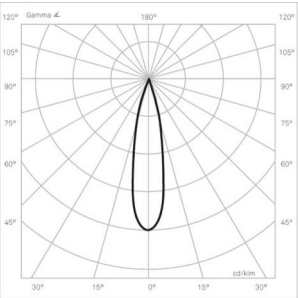
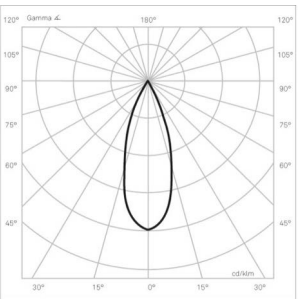
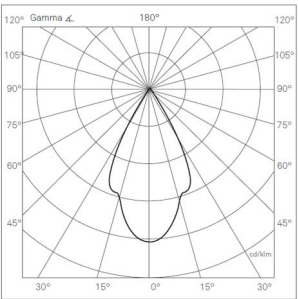

PHOTOMETRY

<p>930 13° SR16</p>		<table border="1"> <thead> <tr> <th rowspan="2">Height (m)</th> <th colspan="3">E (lx)</th> <th rowspan="2">D (m)</th> </tr> <tr> <th>MX9</th> <th>MX11</th> <th>MX15</th> </tr> </thead> <tbody> <tr> <td>1</td> <td>4966</td> <td>6138</td> <td>8306</td> <td>0.24</td> </tr> <tr> <td>2</td> <td>1242</td> <td>1534</td> <td>2077</td> <td>0.48</td> </tr> <tr> <td>3</td> <td>552</td> <td>682</td> <td>923</td> <td>0.72</td> </tr> <tr> <td>4</td> <td>310</td> <td>384</td> <td>519</td> <td>0.96</td> </tr> <tr> <td>5</td> <td>199</td> <td>246</td> <td>332</td> <td>1.20</td> </tr> <tr> <td>I(cd)</td> <td>4974</td> <td>6153</td> <td>8302</td> <td></td> </tr> </tbody> </table>	Height (m)	E (lx)			D (m)	MX9	MX11	MX15	1	4966	6138	8306	0.24	2	1242	1534	2077	0.48	3	552	682	923	0.72	4	310	384	519	0.96	5	199	246	332	1.20	I(cd)	4974	6153	8302	
Height (m)	E (lx)			D (m)																																				
	MX9	MX11	MX15																																					
1	4966	6138	8306	0.24																																				
2	1242	1534	2077	0.48																																				
3	552	682	923	0.72																																				
4	310	384	519	0.96																																				
5	199	246	332	1.20																																				
I(cd)	4974	6153	8302																																					
<p>930 24° SR16</p>		<table border="1"> <thead> <tr> <th rowspan="2">Height (m)</th> <th colspan="3">E (lx)</th> <th rowspan="2">D (m)</th> </tr> <tr> <th>MX9</th> <th>MX11</th> <th>MX15</th> </tr> </thead> <tbody> <tr> <td>1</td> <td>1549</td> <td>2017</td> <td>3006</td> <td>0.42</td> </tr> <tr> <td>2</td> <td>387</td> <td>504</td> <td>752</td> <td>0.84</td> </tr> <tr> <td>3</td> <td>172</td> <td>224</td> <td>334</td> <td>1.26</td> </tr> <tr> <td>4</td> <td>97</td> <td>126</td> <td>188</td> <td>1.68</td> </tr> <tr> <td>5</td> <td>62</td> <td>81</td> <td>120</td> <td>2.1</td> </tr> <tr> <td>I(cd)</td> <td>1548</td> <td>2027</td> <td>3006</td> <td></td> </tr> </tbody> </table>	Height (m)	E (lx)			D (m)	MX9	MX11	MX15	1	1549	2017	3006	0.42	2	387	504	752	0.84	3	172	224	334	1.26	4	97	126	188	1.68	5	62	81	120	2.1	I(cd)	1548	2027	3006	
Height (m)	E (lx)			D (m)																																				
	MX9	MX11	MX15																																					
1	1549	2017	3006	0.42																																				
2	387	504	752	0.84																																				
3	172	224	334	1.26																																				
4	97	126	188	1.68																																				
5	62	81	120	2.1																																				
I(cd)	1548	2027	3006																																					
<p>930 38° SR16</p>		<table border="1"> <thead> <tr> <th rowspan="2">Height (m)</th> <th colspan="3">E (lx)</th> <th rowspan="2">D (m)</th> </tr> <tr> <th>MX9</th> <th>MX11</th> <th>MX15</th> </tr> </thead> <tbody> <tr> <td>1</td> <td>892</td> <td>1168</td> <td>1727</td> <td>0.70</td> </tr> <tr> <td>2</td> <td>223</td> <td>292</td> <td>432</td> <td>1.40</td> </tr> <tr> <td>3</td> <td>99</td> <td>130</td> <td>192</td> <td>2.10</td> </tr> <tr> <td>4</td> <td>56</td> <td>73</td> <td>108</td> <td>2.80</td> </tr> <tr> <td>5</td> <td>36</td> <td>47</td> <td>69</td> <td>3.50</td> </tr> <tr> <td>I(cd)</td> <td>891</td> <td>1169</td> <td>1735</td> <td></td> </tr> </tbody> </table>	Height (m)	E (lx)			D (m)	MX9	MX11	MX15	1	892	1168	1727	0.70	2	223	292	432	1.40	3	99	130	192	2.10	4	56	73	108	2.80	5	36	47	69	3.50	I(cd)	891	1169	1735	
Height (m)	E (lx)			D (m)																																				
	MX9	MX11	MX15																																					
1	892	1168	1727	0.70																																				
2	223	292	432	1.40																																				
3	99	130	192	2.10																																				
4	56	73	108	2.80																																				
5	36	47	69	3.50																																				
I(cd)	891	1169	1735																																					
<p>930 55° SR16</p>		<table border="1"> <thead> <tr> <th rowspan="2">Height (m)</th> <th colspan="3">E (lx)</th> <th rowspan="2">D (m)</th> </tr> <tr> <th>MX9</th> <th>MX11</th> <th>MX15</th> </tr> </thead> <tbody> <tr> <td>1</td> <td>657</td> <td>843</td> <td>1245</td> <td>1.08</td> </tr> <tr> <td>2</td> <td>164</td> <td>211</td> <td>311</td> <td>2.16</td> </tr> <tr> <td>3</td> <td>73</td> <td>94</td> <td>138</td> <td>3.24</td> </tr> <tr> <td>4</td> <td>41</td> <td>53</td> <td>78</td> <td>4.32</td> </tr> <tr> <td>5</td> <td>26</td> <td>34</td> <td>50</td> <td>5.4</td> </tr> <tr> <td>I(cd)</td> <td>641</td> <td>842</td> <td>1247</td> <td></td> </tr> </tbody> </table>	Height (m)	E (lx)			D (m)	MX9	MX11	MX15	1	657	843	1245	1.08	2	164	211	311	2.16	3	73	94	138	3.24	4	41	53	78	4.32	5	26	34	50	5.4	I(cd)	641	842	1247	
Height (m)	E (lx)			D (m)																																				
	MX9	MX11	MX15																																					
1	657	843	1245	1.08																																				
2	164	211	311	2.16																																				
3	73	94	138	3.24																																				
4	41	53	78	4.32																																				
5	26	34	50	5.4																																				
I(cd)	641	842	1247																																					

DIMENSIONS

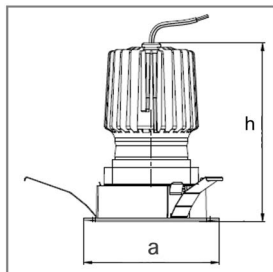

SR ID DL	Modular X	Øa (mm)	h (mm)
SRDY	MX9	86	83
	MX11		109
	MX15		117



diffusing / spread lens

DF / SPD

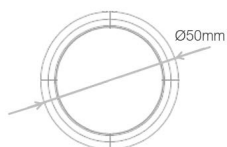

honeycomb

HC

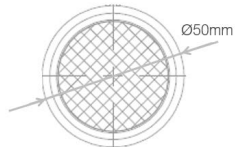

deep recessed anti-glare snoot

SN

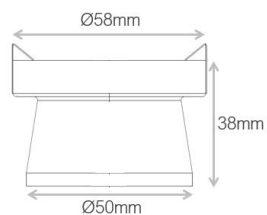



CONNECTION

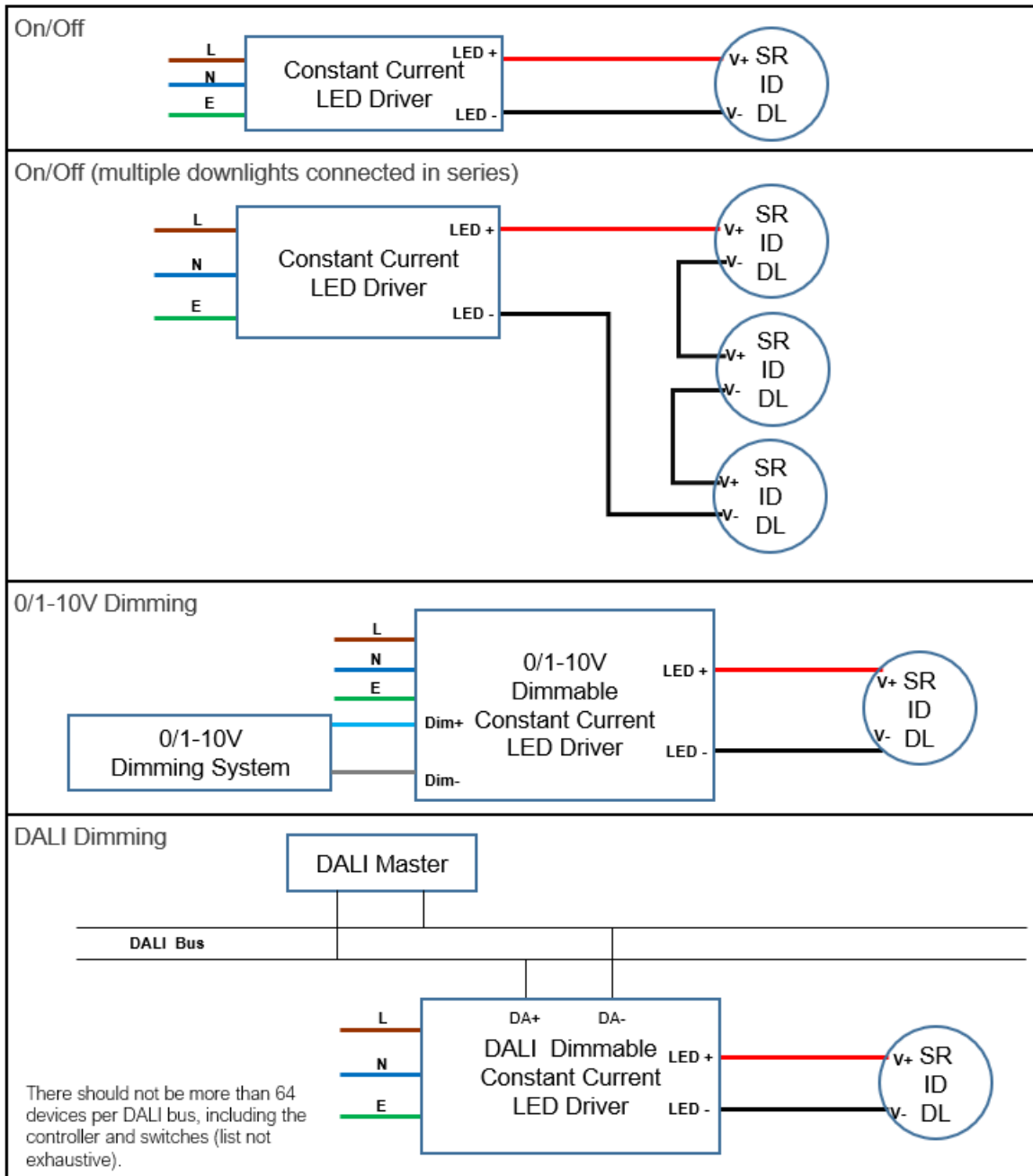

Consult your local sales team for other control protocols, e.g., DMX.



**ORDERING INFORMATION**

Select one component from each column to specify a complete ordering code

SR ID DL Dyna Series	Modular X	CRI/CCT	Beam Angle *	IP	Trim Color †	Reflector Color †	Accessory ‡	Module Cap
SRDY	MX9 MX11 MX15	927 930 940 827 830 840 850	NRB MDB WDB FLD	40 65	B W	B W MIR DRM	DF HC SN SPD NA	SR16 SR6

Example: SRDY-MX15-930-WDB-40-W-MIR-NA-SR16 refers to SR ID DL Dyna Series, Modular X15 (15W), CRI Ra90+, CCT 3000K, beam angle 38°, IP40, white trim finishing with mirror reflector.

* Beam Angle Ordering Code	Beam Angle
NRB	13°
MDB	24°
WDB	38°
FLD	55°

† Trim / Reflector Color Options	Color Description
B	black
W	white
MIR	mirror
DRM	dark mirror

‡ Accessory Options	Description
DF	diffuser
HC	honeycomb
SN	snoot
SPD	spread lens
NA	no accessory

**Disclaimer:** Data might vary due to equipment tolerance. Manufacturer reserves the right to make changes to information published in this document, including without limitation specifications and product descriptions, at any time and without notice.