



SR Contour Light

CONT V SLIM MONOCHROMATIC SERIES



SUMMARY

bend dir.  VERTICAL	min bend radius 8cm	dimension 	max length 5m	cutting pitch 83.3mm for 2200K, 2400K 25mm for 3000K, 4000K, 5000K
IP indoor: IP44 outdoor: IP67	power 2.4W/m 4.8W/m 7.2W/m 9.6W/m 12.0W/m	beam 120°	color 2200K 3000K 2400K 4000K 2700K 5000K	CRI Ra 80+ Ra 90+

FEATURES

- Excellent thermal dissipation encapsulated with high performance grade silicone material that can be used and installed at an extreme harsh environment with temperature up to 65°C
- Designed to be UV and corrosion resistant; meet UL 94 V-0 standard
- One of the smallest bend radius, 8cm, available in market, to meet various design requirements
- Maximum height of only 14.2mm with profile, providing unparalleled option for the ever-demanding height constraints
- High uniformity with no dark spot even at the terminals
- A versatile series providing for various applications covering soft glow effect to a high lumen output of 900lm/m
- SR® LEDShield technology†
- Lifetime: 50,000 hours

DIMMING OPTIONS



ELECTRICAL

Supply voltage: DC24.0V±1.0V

Power range and supply current:

	Power	Current
I/ONJ02	2.4W/m	100mA/m
I/ONJ04	4.8W/m	200mA/m
I/ONJ07	7.2W/m	300mA/m
I/ONJ09	9.6W/m	400mA/m
I/ONJ12	12.0W/m	500mA/m

ESD protection: contact 4kV, air 8kV

MECHANICAL

Minimum bending radius: 8cm

Maximum length: 5m

Cutting pitch:

CCT	Cutting Pitch
2200K, 2400K	83.3mm
2700K, 3000K, 4000K, 5000K	25mm

IP: IP44/IP67

LIGHT OUTPUT

Luminaire Lumen Output:

lm/m	822	824	827	830	840	850
I/ONJ02	153	153	180	180	190	190
I/ONJ04	310	310	365	365	375	375
I/ONJ07	425	425	515	515	545	545
I/ONJ09	582	582	685	685	720	720
I/ONJ12	722	722	850	850	900	900
lm/m	922	924	927	930	940	950
I/ONJ02	125	125	148	148	158	158
I/ONJ04	250	250	295	295	310	310
I/ONJ07	360	360	425	425	45	450
I/ONJ09	475	475	560	560	600	600
I/ONJ12	590	590	700	700	750	750

Beam angle: 120°

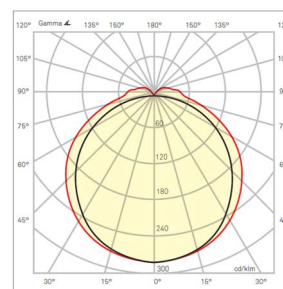

LIFETIME, WARRANTY & COMPLIANCE

Warranty: 2 years*

Lifetime: 50,000 hours, L70/B50@ta 65°C

Compliance:

- EN 62031, EN 62471, EN 60598-1, EN 60598-2-1
- EN 55015, EN 61547
- AS/NZS 60598.1, AS/NZS 60598.2.1

ENVIRONMENT

Ambient temperature: -40°C ... +65°C

Storage temperature: -40°C ... +85°C

Working humidity: 5% to 85%, non-condensing

† SR® LEDShield technology: innovative mechanism protecting segment black out from single LED damage due to inappropriate external force applied during installation and handling.

DIMENSIONS - INDOOR

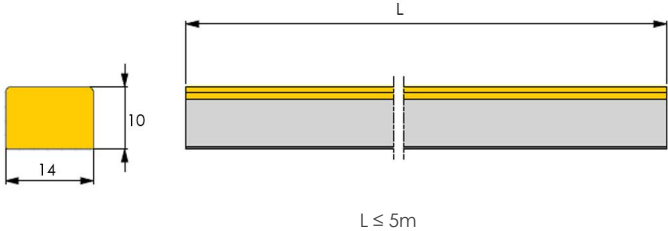
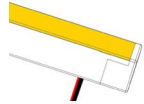
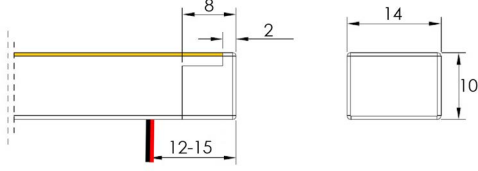
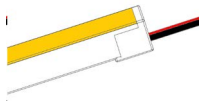
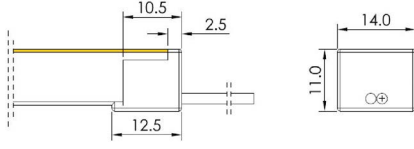
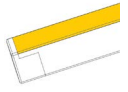
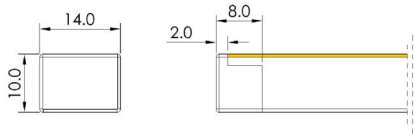
<p>CONT V SLIM INJ Body</p>	
<p>Wire Bottom Feed-in</p> 	
<p>Wire End Feed-in</p> 	
<p>End Cap</p> 	

Additional length added to body length L is 5mm with any one feed-in (added 2.5mm) and end cap (added 2.5mm).

DIMENSIONS - OUTDOOR

<p>CONT V SLIM ONJ Body</p>	<p style="text-align: center;">$L \leq 5m$</p>
<p>Molded Bottom Feed-in (MB)</p>	
<p>Molded End Feed-in (ME)</p>	
<p>Molded Side Feed-in - right (MSR)</p> <div style="border: 1px solid black; padding: 2px; width: fit-content; margin-top: 5px;"> <p>illumination top view</p> <p>side right feed-in</p> </div>	
<p>Molded End Cap</p>	

Additional length added to body length L is 4mm with any one feed-in (added 2mm) and end cap (added 2mm).

MOUNTING ACCESSORIES

CONT V SLIM NJ AL CLIP 50MM (50mm aluminum clip)

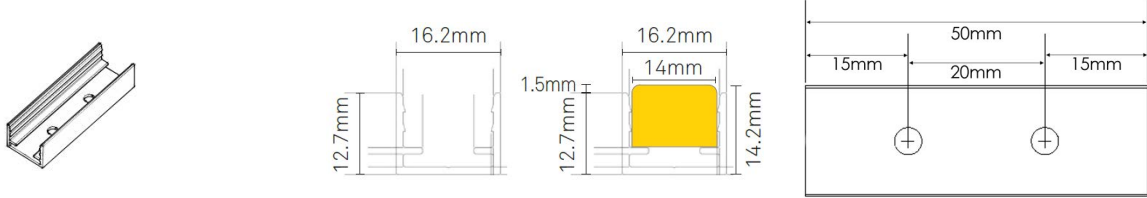

CONT V SLIM NJ AL PROFILE 1M (1m aluminum profile)

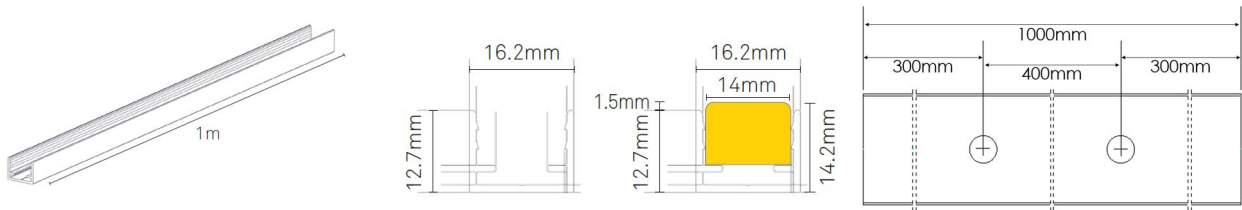

CONT V SLIM NJ 45D ANGLED AL PROFILE 1M (1m 45° angled aluminum profile) - for horizontal installation only

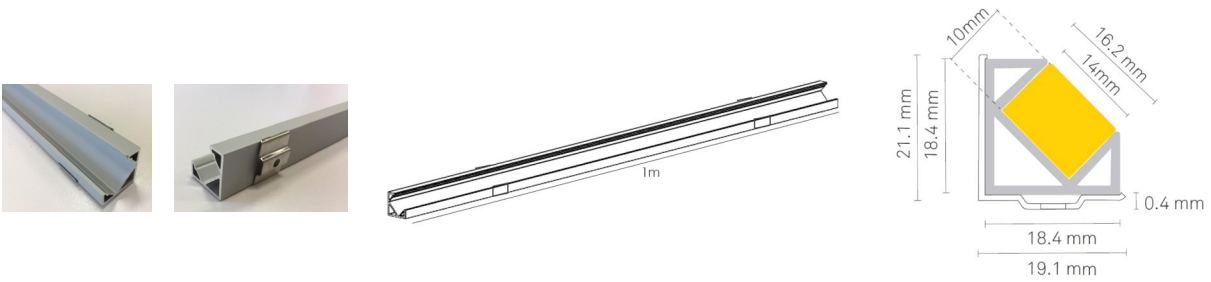

Contact our sales team for consultation on other installation orientation.

SR Contour Light CONT V SLIM MONOCHROMATIC



WIRING

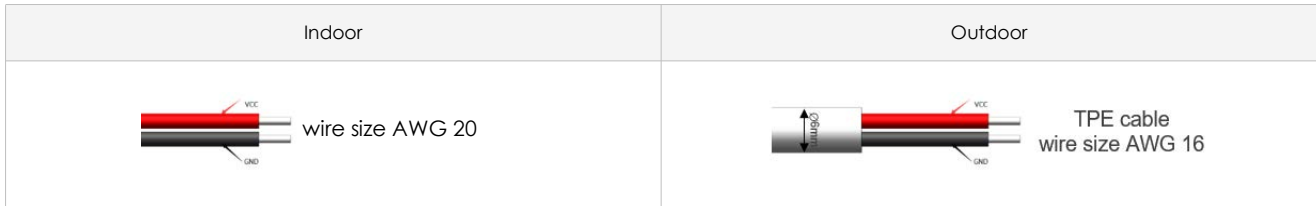

CONNECTIONS

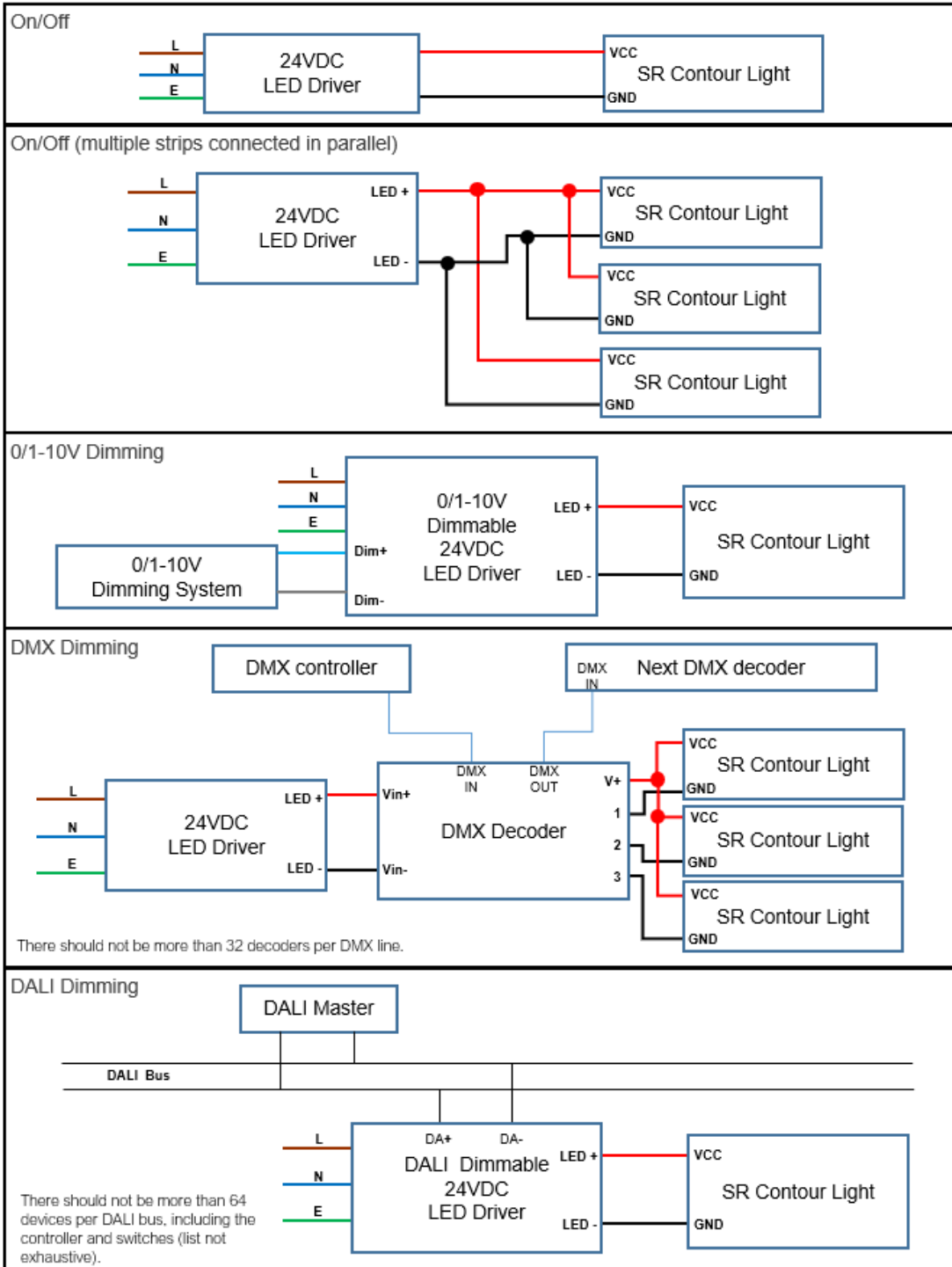

SR Contour Light CONT V SLIM MONOCHROMATIC



ORDERING INFORMATION

SR Contour Light	Power	Feed-in Wire/Cable Direction [†]	CRI / CCT	Length
CONT V SLIM	INJ02	WB WE	822	xM (x = length in meters, max 5)
	INJ04		824	
	INJ07		827	
	INJ09		830	
	INJ12		840	
	ONJ02		850	
	ONJ04	922		
	ONJ07	924		
	ONJ09	927		
	ONJ12	930		
		MSR	940	
			950	

[†]Note:

Feed-in Wire/ Cable Direction	Description
WB	wire bottom feeder
MB	cable bottom feeder
WE	wire end feeder
ME	cable end feeder
MSR	cable side feeder right

Example:

CONT V SLIM INJ12 WB 930 5M refers to SR CONT V SLIM Monochromatic Indoor Series, vertical bend, 12.0W/m, wire bottom feed-in, CRI Ra90+, CCT 3000K, IP44, 5 meters in length.

CONT V SLIM ONJ12 ME 830 5M refers to SR CONT V SLIM Monochromatic Outdoor Series, vertical bend, 12.0W/m, cable end feed-in, CRI Ra80+, CCT 3000K, IP67, 5 meters in length.

Accessory Ordering Code	Description
CONT V SLIM NJ AL CLIP 50MM	aluminum clip, 50mm
CONT V SLIM NJ AL PROFILE 1M	aluminum profile, 1m
CONT V SLIM NJ 45D ANGLED AL PROFILE 1M	45° angled aluminum profile, 1m

LED Drivers	Description
SBV 040N024X167Q	40W 24V Constant Voltage LED Driver
SAV-060N024X02HQA	60W 24V Constant Voltage LED Driver
SAV-096N024X400Q	96W 24V Constant Voltage LED Driver
SAV-150N024X625Q	150W 24V Constant Voltage LED Driver

Note: System design will vary depending on actual project configuration. Please consult your local sales support for details in length in series connection, connecting cable type and lengths.

Disclaimer: Data might vary due to equipment tolerance. Manufacturer reserves the right to make changes to information published in this document, including without limitation specifications and product descriptions, at any time and without notice.